

AURELIA WAVE UX 2GR SPEC SHEET

POWER REQUIREMENT

- Volts: 230V-380V 50/60Hz
- Watts: 5500W (with cupwarmer)
- Watts: 5300W (without cupwarmer)

WATER REQUIREMENT

- 3/8" dedicated cold water line with shut-off valve and compression fitting
- Water hardness cannot exceed 3gpg or 50ppm. If water hardness exceeds 3gpg a water softener must be installed
- Minimum incoming water flow rate of 35 GPH and maximum line pressure of 70 PSI / 5 BAR

WATER SOFTENING EQUIPMENT

- Water Softener Capacity: Single 4400 gpg/ 76000 ppm
- Water Softener Capacity: Double 8800 gpg/ 150000 ppm
- Water Softener Capacity: Triple 13200 gpg / 225000 ppm
- Water Softener Capacity: Automatic - programmable
- Water Softener Capacity: Manual - 4400 gpg/ 76000 ppm

The average water consumption of this machine is 15 liter per day, which represents 196 drinks at 4 Oz/ 0,1 L

WATER SOFTENER / MAINTENANCE CALCULATION

$$\frac{\text{Cartridge grain capacity}}{\text{Water hardness GPG/PDM}} = \text{Liters/ gallons capacity of cartridge} \div \text{Liter/gallons of water used per day} = \text{Days until cartridge needs to be replaced}$$

COUNTER SPACE REQUIREMENTS

- Height: 537mm / 21,1 inches
- Width: 802 mm/ 31,6 inches
- Depth: 605mm / 23,8inches
- Gross Weight: 85 kg / 187 pounds

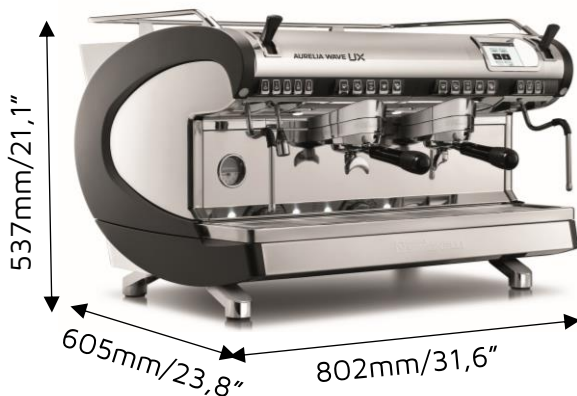

DRAIN REQUIREMENTS

Open gravity drain of minimum 3cm/ 1.25 inch I.D., within 4 feet/1,2 m of the machine.

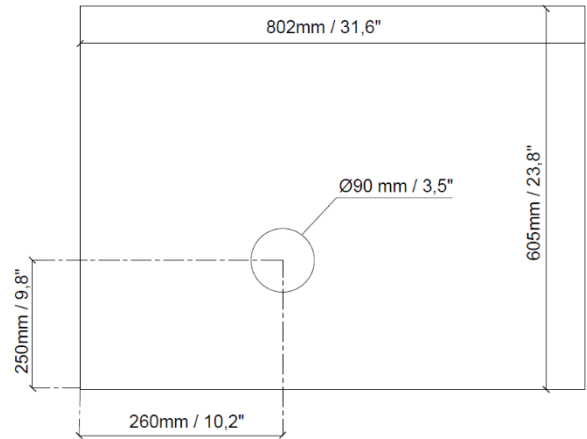

(Front)

Countertop drain hole location

I, the customer, understand that these requirements must be in when the installer arrives. Failure to have the site ready will result in additional service and travel charges and may cause further delays in installation.

Customer Name _____

Company Name _____ Signature: _____

Phone: _____ Email: _____